

Zestawienie podstawowych grzałek

2004-02-27

Parametry wspólne:

Prąd roboczy: 45A
 doprowadzenia "gorące" NiCr 30 cm
 doprowadzenia "zimne" Ni osłonięte ceramiką: 35 cm
 dopuszczalna krótkotrwale temperatura drutu oporowego: 1300 K



MATY GRZEJNE PROSTOKĄTNE

nazwa	S[mm]	L[mm]	U [V]	kod innej	cn	cr
P-01-20	26	423	19	K2-20	168	98
P-01-21	26	444	20	K2-21	170	99
P-01-22	26	465	20	K2-22	173	99
P-01-23	26	486	21	K2-23	175	100
P-01-24	26	508	22	K2-24	178	101
P-01-25	26	529	22	K2-25	180	102
P-01-26	26	550	23	K2-26	183	102
P-01-27	26	571	23	K2-27	186	103
P-01-28	26	592	24	K2-28	188	104
P-01-29	26	613	24	K2-29	191	105
P-01-30	26	634	25	K2-30	193	106
P-01-31	26	656	25	K2-31	196	106
P-01-32	26	677	26	K2-32	198	107
P-01-33	26	698	26	K2-33	201	108
P-01-34	26	719	27	K2-34	203	109
P-01-35	26	740	28	K2-35	206	110
P-01-36	26	761	28	K2-36	208	110
P-01-37	26	782	29	K2-37	211	111
P-01-38	26	804	29	K2-38	214	112
P-01-39	26	825	30	K2-39	216	113
P-01-40	26	846	30	K2-40	219	114
P-01-41	26	867	31	K2-41	221	114
P-01-42	26	888	31	K2-42	224	115
P-01-43	26	909	32	K2-43	226	116
P-01-44	26	930	32	K2-44	229	117
P-01-45	26	952	33	K2-45	231	118
P-01-46	26	973	34	K2-46	234	118
P-01-47	26	994	34	K2-47	237	119
P-01-48	26	1015	35	K2-48	239	120
P-01-49	26	1036	35	K2-49	242	121
P-01-50	26	1057	36	K2-50	244	122
P-01-51	26	1079	36	K2-51	247	122
P-01-52	26	1100	37	K2-52	249	123
P-01-53	26	1121	37	K2-53	252	124
P-01-54	26	1142	38	K2-54	254	125
P-01-55	26	1163	38	K2-55	257	126
P-01-56	26	1184	39	K2-56	259	126
P-01-57	26	1205	39	K2-57	262	127
P-01-58	26	1227	40	K2-58	265	128
P-01-59	26	1248	41	K2-59	267	129
P-01-60	26	1269	41	K2-60	270	130
P-01-61	26	1290	42	K2-61	272	130
P-01-62	26	1311	42	K2-62	275	131
P-01-63	26	1332	43	K2-63	277	132
P-01-64	26	1353	43	K2-64	280	133
P-01-65	26	1375	44	K2-65	282	134
P-01-66	26	1396	44	K2-66	285	134
P-01-67	26	1417	45	K2-67	288	135
P-01-68	26	1438	45	K2-68	290	136
P-01-69	26	1459	46	K2-69	293	137

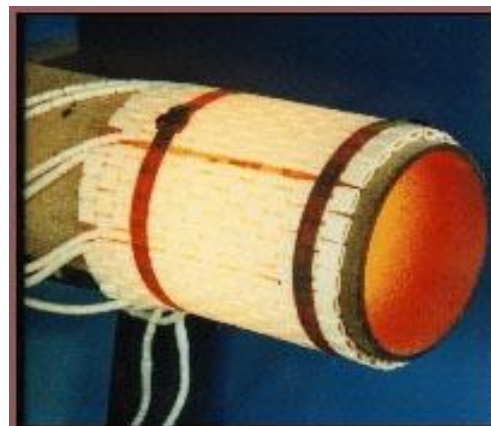

nazwa	S[mm]	L[mm]	U [V]	kod innej	cn	cr
P-01-70	26	1480	47	K2-70	295	138
P-01-71	26	1501	47	K2-71	298	138
P-01-72	26	1523	48	K2-72	300	139
P-01-73	26	1544	48	K2-73	303	140
P-01-74	26	1565	49	K2-74	305	141
P-01-75	26	1586	49	K2-75	308	142
P-01-76	26	1607	50	K2-76	310	142
P-01-77	26	1628	50	K2-77	313	143
P-01-78	26	1649	51	K2-78	316	144
P-01-79	26	1671	51	K2-79	318	145
P-01-80	26	1692	52	K2-80	321	146
P-01-81	26	1713	53	K2-81	323	146
P-01-82	26	1734	53	K2-82	326	147
P-01-83	26	1755	54	K2-83	328	148
P-01-84	26	1776	54	K2-84	331	149
P-01-85	26	1798	55	K2-85	333	149
P-01-86	26	1819	55	K2-86	336	150
P-01-87	26	1840	56	K2-87	339	151
P-01-88	26	1861	56	K2-88	341	152
P-01-89	26	1882	57	K2-89	344	153
P-01-90	26	1903	57	K2-90	346	153
P-01-91	26	1924	58	K2-91	349	154
P-01-92	26	1946	59	K2-92	351	155
P-01-93	26	1967	59	K2-93	354	156
P-01-94	26	1988	60	K2-94	356	157
P-01-95	26	2009	60	K2-95	359	157
P-01-96	26	2030	61	K2-96	361	158
P-01-97	26	2051	61	K2-97	364	159
P-01-98	26	2072	62	K2-98	367	160
P-01-99	26	2094	62	K2-99	369	161
P-01-100	26	2115	63	K2-100	372	161
P-01-101	26	2136	63	K2-101	374	162
P-01-102	26	2157	64	K2-102	377	163
P-01-103	26	2178	65	K2-103	379	164
P-01-104	26	2199	65	K2-104	382	165
P-01-105	26	2220	66	K2-105	384	165
P-01-106	26	2242	66	K2-106	387	166
P-01-107	26	2263	67	K2-107	390	167
P-01-108	26	2284	67	K2-108	392	168
P-01-109	26	2305	68	K2-109	395	169
P-01-110	26	2326	68	K2-110	397	169
P-01-111	26	2347	69	K2-111	400	170
P-01-112	26	2368	69	K2-112	402	171
P-01-113	26	2390	70	K2-113	405	172
P-01-114	26	2411	71	K2-114	407	173
P-01-115	26	2432	71	K2-115	410	173
P-01-116	26	2453	72	K2-116	412	174
P-01-117	26	2474	72	K2-117	415	175
P-01-118	26	2495	73	K2-118	418	176
P-01-119	26	2517	73	K2-119	420	177
P-01-120	26	2538	74	K2-120	423	177
P-01-121	26	2559	74	K2-121	425	178
P-01-122	26	2580	75	K2-122	428	179
P-01-123	26	2601	75	K2-123	430	180
P-01-124	26	2622	76	K2-124	433	181
P-01-125	26	2643	77	K2-125	435	181
P-01-126	26	2665	77	K2-126	438	182
P-01-127	26	2686	78	K2-127	441	183
P-01-128	26	2707	78	K2-128	443	184
P-01-129	26	2728	79	K2-129	446	185
P-01-130	26	2749	79	K2-130	448	185

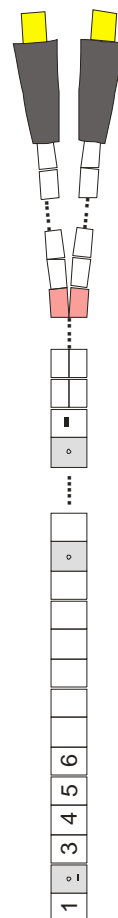

nazwa	S[mm]	L[mm]	U [V]	kod innej	cn	cr
P-01-131	26	2770	80	K2-131	451	186
P-01-132	26	2791	80	K2-132	453	187
P-01-133	26	2813	81	K2-133	456	188
P-01-134	26	2834	81	K2-134	458	189
P-01-135	26	2855	82	K2-135	461	189
P-01-136	26	2876	82	K2-136	463	190
P-01-137	26	2897	83	K2-137	466	191
P-01-138	26	2918	84	K2-138	469	192
P-01-139	26	2939	84	K2-139	471	193
P-01-140	26	2961	85	K2-140	474	193
P-01-141	26	2982	85	K2-141	476	194
P-01-142	26	3003	86	K2-142	479	195
P-01-143	26	3024	86	K2-143	481	196
P-01-144	26	3045	87	K2-144	484	197
P-01-145	26	3066	87	K2-145	486	197
P-01-146	26	3087	88	K2-146	489	198
P-01-147	26	3109	88	K2-147	492	199
P-01-148	26	3130	89	K2-148	494	200
P-01-149	26	3151	90	K2-149	497	201
P-01-150	26	3172	90	K2-150	499	201
P-01-151	26	3193	91	K2-151	502	202
P-01-152	26	3214	91	K2-152	504	203
P-01-153	26	3236	92	K2-153	507	204
P-01-154	26	3257	92	K2-154	509	204
P-01-155	26	3278	93	K2-155	512	205
P-01-156	26	3299	93	K2-156	514	206
P-01-157	26	3320	94	K2-157	517	207
P-01-158	26	3341	94	K2-158	520	208
P-01-159	26	3362	95	K2-159	522	208
P-01-160	26	3384	96	K2-160	525	209
P-01-161	26	3405	96	K2-161	527	210
P-01-162	26	3426	97	K2-162	530	211
P-01-163	26	3447	97	K2-163	532	212
P-01-164	26	3468	98	K2-164	535	212
P-01-165	26	3489	98	K2-165	537	213
P-01-166	26	3510	99	K2-166	540	214
P-01-167	26	3532	99	K2-167	543	215
P-01-168	26	3553	100	K2-168	545	216
P-02-10	52	211	19		160	99
P-02-11	52	233	20		164	100
P-02-12	52	254	22		169	102
P-02-13	52	275	23		173	103
P-02-14	52	296	24		177	105
P-02-15	52	317	25		182	106
P-02-16	52	338	26		186	108
P-02-17	52	360	27		190	109
P-02-18	52	381	28		194	111
P-02-19	52	402	29		198	112
P-02-20	52	423	30		203	114
P-02-21	52	444	31		207	116
P-02-22	52	465	32		211	117
P-02-23	52	486	34		216	119
P-02-24	52	508	35		220	120
P-02-25	52	529	36		224	122
P-02-26	52	550	37		229	123
P-02-27	52	571	38		233	125
P-02-28	52	592	39		237	126
P-02-29	52	613	40		241	128
P-02-30	52	634	41		246	129
P-02-31	52	656	42		250	131
P-02-32	52	677	43		254	132

nazwa	S[mm]	L[mm]	U [V]	kod innej	cn	cr
P-02-33	52	698	44		259	134
P-02-34	52	719	46		263	135
P-02-35	52	740	47		267	137
P-02-36	52	761	48		272	138
P-02-37	52	782	49		276	140
P-02-38	52	804	50		280	141
P-02-39	52	825	51		284	143
P-02-40	52	846	52		289	144
P-02-41	52	867	53		293	146
P-02-42	52	888	54		297	147
P-02-43	52	909	55		301	149
P-02-44	52	930	56		306	150
P-02-45	52	952	57		310	152
P-02-46	52	973	59		314	153
P-02-47	52	994	60		319	155
P-02-48	52	1015	61		323	156
P-02-49	52	1036	62		327	158
P-02-50	52	1057	63		332	159
P-02-51	52	1079	64		336	161
P-02-52	52	1100	65		340	162
P-02-53	52	1121	66		344	164
P-02-54	52	1142	67		349	165
P-02-55	52	1163	68		353	167
P-02-56	52	1184	69		357	168
P-02-57	52	1205	71		362	170
P-02-58	52	1227	72		366	171
P-02-59	52	1248	73		370	173
P-02-60	52	1269	74		375	174
P-02-61	52	1290	75		379	176
P-02-62	52	1311	76		383	177
P-02-63	52	1332	77		387	179
P-02-64	52	1353	78		391	180
P-02-65	52	1375	79		396	182
P-02-66	52	1396	80		400	183
P-02-67	52	1417	81		404	185
P-02-68	52	1438	83		409	186
P-02-69	52	1459	84		413	188
P-02-70	52	1480	85		418	189
P-02-71	52	1501	86		422	191
P-02-72	52	1523	87		426	192
P-02-73	52	1544	88		430	194
P-02-74	52	1565	89		434	195
P-02-75	52	1586	90		439	197
P-02-76	52	1607	91		443	198
P-02-77	52	1628	92		447	200
P-02-78	52	1649	93		452	201
P-02-79	52	1671	94		456	203
P-02-80	52	1692	96		460	205
P-02-81	52	1713	97		465	206
P-02-82	52	1734	98		469	208
P-02-83	52	1755	99		473	209
P-03-06	77	127	18		154	99
P-03-07	77	148	20		160	101
P-03-08	77	169	22		166	104
P-03-09	77	190	23		172	106
P-03-10	77	211	25		178	108
P-03-11	77	233	26		184	110
P-03-12	77	254	28		190	113
P-03-13	77	275	30		196	115
P-03-14	77	296	31		202	117
P-03-15	77	317	33		208	119

nazwa	S[mm]	L[mm]	U [V]	kod innej	cn	cr
P-03-16	77	338	35		214	121
P-03-17	77	360	36		220	124
P-03-18	77	381	38		226	126
P-03-19	77	402	40		232	128
P-03-20	77	423	41		238	130
P-03-21	77	444	43		244	133
P-03-22	77	465	44		250	135
P-03-23	77	486	46		256	137
P-03-24	77	508	48		262	139
P-03-25	77	529	49		268	141
P-03-26	77	550	51		274	144
P-03-27	77	571	53		280	146
P-03-28	77	592	54		286	148
P-03-29	77	613	56		292	150
P-03-30	77	634	58		298	152
P-03-31	77	656	59		304	155
P-03-32	77	677	61		310	157
P-03-33	77	698	62		316	159
P-03-34	77	719	64		323	161
P-03-35	77	740	66		329	164
P-03-36	77	761	67		334	166
P-03-37	77	782	69		341	168
P-03-38	77	804	71		347	170
P-03-39	77	825	72		353	172
P-03-40	77	846	74		358	175
P-03-41	77	867	75		365	177
P-03-42	77	888	77		371	179
P-03-43	77	909	79		377	181
P-03-44	77	930	80		383	184
P-03-45	77	952	82		389	186
P-03-46	77	973	84		395	188
P-03-47	77	994	85		401	190
P-03-48	77	1015	87		407	192
P-03-49	77	1036	89		413	195
P-03-50	77	1057	90		419	197
P-03-51	77	1079	92		425	199
P-03-52	77	1100	93		431	201
P-03-53	77	1121	95		437	204
P-03-54	77	1142	97		443	206
P-03-55	77	1163	98		449	208
P-04-05	103	106	19		157	103
P-04-06	103	127	22		165	106
P-04-07	103	148	24		172	108
P-04-08	103	169	26		180	111
P-04-09	103	190	28		188	114
P-04-10	103	211	30		195	117
P-04-11	103	233	32		203	120
P-04-12	103	254	35		211	123
P-04-13	103	275	37		219	126
P-04-14	103	296	39		227	129
P-04-15	103	317	41		234	132
P-04-16	103	338	43		242	135
P-04-17	103	360	46		250	138
P-04-18	103	381	48		258	141
P-04-19	103	402	50		266	144
P-04-20	103	423	52		273	147
P-04-21	103	444	54		281	150
P-04-22	103	465	56		289	152
P-04-23	103	486	59		296	155
P-04-24	103	508	61		304	158
P-04-25	103	529	63		312	161

nazwa	S[mm]	L[mm]	U [V]	kod innej	cn	cr
P-04-26	103	550	65		320	164
P-04-27	103	571	67		328	167
P-04-28	103	592	70		335	170
P-04-29	103	613	72		343	173
P-04-30	103	634	74		351	176
P-04-31	103	656	76		359	179
P-04-32	103	677	78		366	182
P-04-33	103	698	80		374	185
P-04-34	103	719	83		382	188
P-04-35	103	740	85		390	191
P-04-36	103	761	87		398	194
P-04-37	103	782	89		405	196
P-04-38	103	804	91		413	199
P-04-39	103	825	93		421	202
P-04-40	103	846	96		429	205
P-04-41	103	867	98		437	208
P-05-04	129	85	19		157	105
P-05-05	129	106	22		166	108
P-05-06	129	127	25		175	112
P-05-07	129	148	28		185	116
P-05-08	129	169	30		194	119
P-05-09	129	190	33		204	123
P-05-10	129	211	36		213	126
P-05-11	129	233	39		223	130
P-05-12	129	254	41		232	134
P-05-13	129	275	44		242	137
P-05-14	129	296	47		251	141
P-05-15	129	317	49		261	145
P-05-16	129	338	52		270	148
P-05-17	129	360	55		280	152
P-05-18	129	381	58		289	156
P-05-19	129	402	60		299	159
P-05-20	129	423	63		308	163
P-05-21	129	444	66		318	167
P-05-22	129	465	68		327	170
P-05-23	129	486	71		337	174
P-05-24	129	508	74		346	177
P-05-25	129	529	77		356	181
P-05-26	129	550	79		365	185
P-05-27	129	571	82		375	188
P-05-28	129	592	85		385	192
P-05-29	129	613	87		394	196
P-05-30	129	634	90		404	199
P-05-31	129	656	93		413	203
P-05-32	129	677	96		423	207
P-05-33	129	698	98		432	210
P-06-03	155	63	18		153	105
P-06-04	155	85	22		164	109
P-06-05	155	106	25		175	114
P-06-06	155	127	28		186	118
P-06-07	155	148	31		197	123
P-06-08	155	169	35		209	127
P-06-09	155	190	38		220	131
P-06-10	155	211	41		231	136
P-06-11	155	233	45		242	140
P-06-12	155	254	48		254	144
P-06-13	155	275	51		265	149
P-06-14	155	296	54		276	153
P-06-15	155	317	58		287	157
P-06-16	155	338	61		298	162
P-06-17	155	360	64		310	166

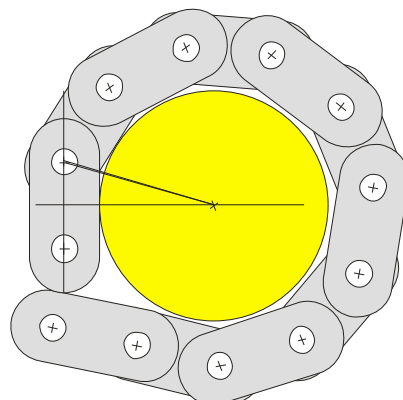
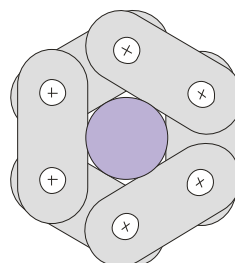

nazwa	S[mm]	L[mm]	U [V]	kod innej	cn	cr
P-06-18	155	381	67		321	170
P-06-19	155	402	71		332	175
P-06-20	155	423	74		344	179
P-06-21	155	444	77		355	183
P-06-22	155	465	80		366	188
P-06-23	155	486	84		378	192
P-06-24	155	508	87		389	197
P-06-25	155	529	90		400	201
P-06-26	155	550	94		411	205
P-06-27	155	571	97		422	210
P-07-02	180	42	16	T-7	145	104
P-07-03	180	63	20		159	109
P-07-04	180	85	24		171	114
P-07-05	180	106	28		184	119
P-07-06	180	127	31		197	124
P-07-07	180	148	35		210	130
P-07-08	180	169	39		223	135
P-07-09	180	190	43		236	140
P-07-10	180	211	47		249	145
P-07-11	180	233	51		262	150
P-07-12	180	254	54		275	155
P-07-13	180	275	58		288	160
P-07-14	180	296	62		301	165
P-07-15	180	317	66		314	170
P-07-16	180	338	70		327	175
P-07-17	180	360	73		340	180
P-07-18	180	381	77		353	185
P-07-19	180	402	81		366	190
P-07-20	180	423	85		379	195
P-07-21	180	444	89		392	200
P-07-22	180	465	92		405	206
P-07-23	180	486	96		418	211
P-08-02	206	42	17	T-8	149	108
P-08-03	206	63	22		164	114
P-08-04	206	85	26		179	119
P-08-05	206	106	30		193	125
P-08-06	206	127	35		208	131
P-08-07	206	148	39		223	137
P-08-08	206	169	43		237	142
P-08-09	206	190	48		252	148
P-08-10	206	211	52		267	154
P-08-11	206	233	57		281	160
P-08-12	206	254	61		296	165
P-08-13	206	275	65		311	171
P-08-14	206	296	70		326	177
P-08-15	206	317	74		340	183
P-08-16	206	338	78		355	189
P-08-17	206	360	83		370	194
P-08-18	206	381	87		385	200
P-08-19	206	402	91		399	206
P-08-20	206	423	96		414	212
P-09-02	232	42	18	T-9	153	111
P-09-03	232	63	23		170	118
P-09-04	232	85	28		186	124
P-09-05	232	106	33		202	131
P-09-06	232	127	38		219	137
P-09-07	232	148	43		235	144
P-09-08	232	169	48		251	150
P-09-09	232	190	53		268	157
P-09-10	232	211	58		284	163
P-09-11	232	233	63		301	170

nazwa	S[mm]	L[mm]	U [V]	kod innej	cn	cr
P-09-12	232	254	67		317	176
P-09-13	232	275	72		334	183
P-09-14	232	296	77		351	189
P-09-15	232	317	82		367	196
P-09-16	232	338	87		384	202
P-09-17	232	360	92		400	209
P-09-18	232	381	97		416	215
P-10-02	258	42	20	T-10	157	115
P-10-03	258	63	25		175	122
P-10-04	258	85	30		193	129
P-10-05	258	106	36		211	136
P-10-06	258	127	41		230	143
P-10-07	258	148	47		248	151
P-10-08	258	169	52		266	158
P-10-09	258	190	58		284	165
P-10-10	258	211	63		302	172
P-10-11	258	233	69		321	179
P-10-12	258	254	74		339	187
P-10-13	258	275	79		357	194
P-10-14	258	296	85		375	201
P-10-15	258	317	90		393	208
P-10-16	258	338	96		412	215
P-11-02	283	42	21	T-11	161	118
P-11-03	283	63	27		181	126
P-11-04	283	85	33		200	134
P-11-05	283	106	39		220	142
P-11-06	283	127	45		240	150
P-11-07	283	148	51		261	158
P-11-08	283	169	57		280	166
P-11-09	283	190	63		300	174
P-11-10	283	211	69		320	181
P-11-11	283	233	75		340	189
P-11-12	283	254	81		360	197
P-11-13	283	275	87		380	205
P-11-14	283	296	93		400	213
P-11-15	283	317	99		420	221
P-12-02	309	42	22	T-12	164	122
P-12-03	309	63	28		186	130
P-12-04	309	85	35		208	139
P-12-05	309	106	41		230	147
P-12-06	309	127	48		251	156
P-12-07	309	148	54		273	165
P-12-08	309	169	61		294	173
P-12-09	309	190	68		316	182
P-12-10	309	211	74		338	191
P-12-11	309	233	81		360	199
P-12-12	309	254	87		381	208
P-12-13	309	275	94		403	216
P-13-02	335	42	23	T-13	168	125
P-13-03	335	63	30		192	134
P-13-04	335	85	37		215	144
P-13-05	335	106	44		239	153
P-13-06	335	127	51		262	162
P-13-07	335	148	58		286	172
P-13-08	335	169	65		309	181
P-13-09	335	190	72		332	190
P-13-10	335	211	80		356	200
P-13-11	335	233	87		379	209
P-13-12	335	254	94		403	218
P-14-02	361	42	24	T-14	172	128
P-14-03	361	63	32		198	139

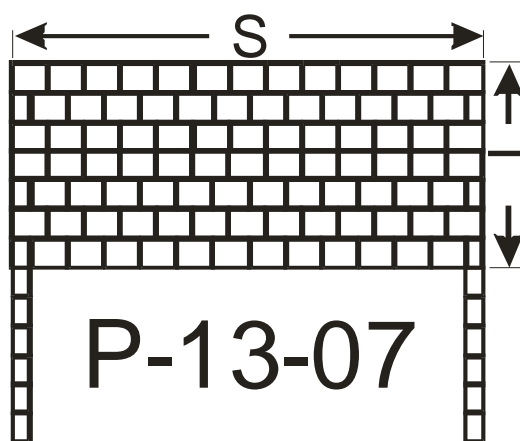
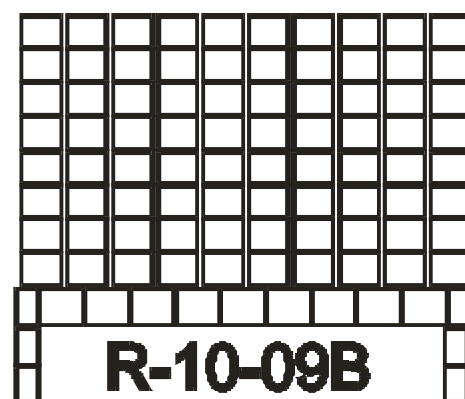
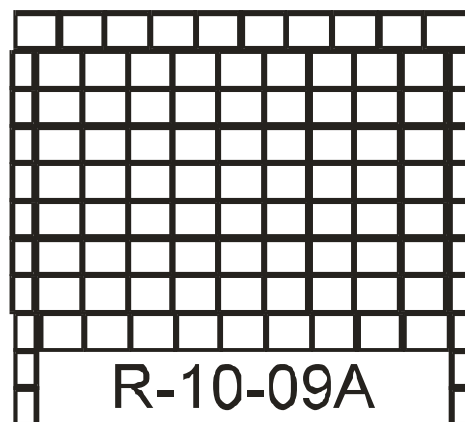

nazwa	S[mm]	L[mm]	U [V]	kod innej	cn	cr
P-14-04	361	85	39		223	149
P-14-05	361	106	47		248	159
P-14-06	361	127	55		273	169
P-14-07	361	148	62		298	179
P-14-08	361	169	70		323	189
P-14-09	361	190	77		348	199
P-14-10	361	211	85		373	209
P-14-11	361	233	93		399	219
P-15-02	386	42	25	T-15	176	132
P-15-03	386	63	33		203	143
P-15-04	386	85	41		230	153
P-15-05	386	106	50		257	164
P-15-06	386	127	58		284	175
P-15-07	386	148	66		311	186
P-15-08	386	169	74		338	197
P-15-09	386	190	82		365	207
P-15-10	386	211	90		391	218
P-15-11	386	233	99		418	229
P-16-02	412	42	26	T-16	180	135
P-16-03	412	63	35		209	147
P-16-04	412	85	44		237	158
P-16-05	412	106	52		266	170
P-16-06	412	127	61		294	181
P-16-07	412	148	70		323	193
P-16-08	412	169	79		352	204
P-16-09	412	190	87		380	216
P-16-10	412	211	96		409	227
P-17-02	438	42	27	T-17	184	139
P-17-03	438	63	37		214	151
P-17-04	438	85	46		244	163
P-17-05	438	106	55		275	175
P-17-06	438	127	64		305	188
P-17-07	438	148	74		336	200
P-17-08	438	169	83		366	212
P-17-09	438	190	92		397	224
P-18-02	464	42	28	T-18	188	142
P-18-03	464	63	38		220	155
P-18-04	464	85	48		252	168
P-18-05	464	106	58		284	181
P-18-06	464	127	68		316	194
P-18-07	464	148	77		348	207
P-18-08	464	169	87		381	220
P-18-09	464	190	97		413	233
P-19-02	489	42	30	T-19	192	146
P-19-03	489	63	40		226	159
P-19-04	489	85	50		259	173
P-19-05	489	106	61		293	187
P-19-06	489	127	71		327	200
P-19-07	489	148	81		361	214
P-19-08	489	169	92		395	227
P-20-02	515	42	31	T-20	195	149
P-20-03	515	63	42		231	164
P-20-04	515	85	52		267	178
P-20-05	515	106	63		302	192
P-20-06	515	127	74		338	207
P-20-07	515	148	85		374	221
P-20-08	515	169	96		409	235
P-21-02	541	42	32	T-21	199	153
P-21-03	541	63	43		237	168
P-21-04	541	85	55		274	183
P-21-05	541	106	66		311	198



nazwa	S[mm]	L[mm]	U [V]	kod innej	cn	cr
P-21-06	541	127	78		349	213
P-21-07	541	148	89		386	228
P-22-02	567	42	33	T-22	203	156
P-22-03	567	63	45		242	172
P-22-04	567	85	57		281	188
P-22-05	567	106	69		321	204
P-22-06	567	127	81		360	219
P-22-07	567	148	93		399	235
P-23-02	592	42	34	T-23	207	160
P-23-03	592	63	47		248	176
P-23-04	592	85	59		289	193
P-23-05	592	106	72		330	209
P-23-06	592	127	84		370	226
P-23-07	592	148	97		411	242
P-24-02	618	42	35	T-24	211	163
P-24-03	618	63	48		253	180
P-24-04	618	85	61		296	198
P-24-05	618	106	74		339	215
P-24-06	618	127	87		381	232
P-25-02	644	42	36	T-25	215	167
P-25-03	644	63	50		259	185
P-25-04	644	85	64		304	202
P-25-05	644	106	77		348	220
P-25-06	644	127	91		392	238
P-26-02	670	42	37	T-26	219	170
P-26-03	670	63	52		265	189
P-26-04	670	85	66		311	207
P-26-05	670	106	80		357	226
P-26-06	670	127	94		403	245
P-27-02	695	42	39	T-27	223	174
P-27-03	695	63	53		271	193
P-27-04	695	85	68		318	212
P-27-05	695	106	83		366	232
P-27-06	695	127	97		414	251
P-28-02	721	42	40	T-28	227	177
P-28-03	721	63	55		276	197
P-28-04	721	85	70		326	217
P-28-05	721	106	85		375	237
P-29-02	747	42	41	T-29	230	181
P-29-03	747	63	57		282	201
P-29-04	747	85	72		333	222
P-29-05	747	106	88		384	243
P-30-02	773	42	42	T-30	234	184
P-30-03	773	63	58		287	205
P-30-04	773	85	75		340	227
P-30-05	773	106	91		393	248
P-31-02	798	42	43	T-31	238	188
P-31-03	798	63	60		293	210
P-31-04	798	85	77		348	232
P-31-05	798	106	94		402	254
P-32-02	824	42	44	T-32	242	191
P-32-03	824	63	62		298	214
P-32-04	824	85	79		355	237
P-32-05	824	106	96		412	260
P-33-02	850	42	45	T-33	246	194
P-33-03	850	63	63		304	218
P-33-04	850	85	81		363	242
P-34-02	876	42	46	T-34	250	198
P-34-03	876	63	65		310	222
P-34-04	876	85	83		370	247
P-35-02	901	42	47	T-35	254	201

nazwa	S[mm]	L[mm]	U [V]	kod innej	cn	cr
P-35-03	901	63	66		316	226
P-35-04	901	85	86		377	251
P-36-02	927	42	49	T-36	258	205
P-36-03	927	63	68		321	231
P-36-04	927	85	88		384	256
P-37-02	953	42	50	T-37	261	208
P-37-03	953	63	70		327	235
P-37-04	953	85	90		392	261
P-38-02	979	42	51	T-38	265	212
P-38-03	979	63	71		332	239
P-38-04	979	85	92		399	266
P-39-02	1004	42	52	T-39	269	215
P-39-03	1004	63	73		338	243
P-39-04	1004	85	94		407	271
P-40-02	1030	42	53	T-40	273	219
P-40-03	1030	63	75		344	247
P-40-04	1030	85	97		414	276
P-41-02	1056	42	54	T-41	277	222
P-41-03	1056	63	76		349	251
P-42-02	1082	42	55	T-42	281	226
P-42-03	1082	63	78		355	256
P-43-02	1107	42	56	T-43	285	229
P-43-03	1107	63	80		360	260
P-44-02	1133	42	57	T-44	289	233
P-44-03	1133	63	81		366	264
P-45-02	1159	42	59	T-45	293	236
P-45-03	1159	63	83		372	268
P-46-02	1185	42	60	T-46	296	240
P-46-03	1185	63	85		377	272
P-47-02	1210	42	61	T-47	300	243
P-47-03	1210	63	86		383	277
P-48-02	1236	42	62	T-48	304	247
P-48-03	1236	63	88		389	281
P-49-02	1262	42	63	T-49	308	250
P-49-03	1262	63	90		394	285
P-50-02	1288	42	64	T-50	312	253
P-50-03	1288	63	91		400	289
P-51-02	1313	42	65	T-51	316	257
P-51-03	1313	63	93		405	293
P-52-02	1339	42	66	T-52	320	260
P-52-03	1339	63	95		411	297
P-53-02	1365	42	67	T-53	324	264
P-54-02	1391	42	69	T-54	327	267
P-55-02	1416	42	70	T-55	331	271
P-56-02	1442	42	71	T-56	335	274
P-57-02	1468	42	72	T-57	339	278
P-58-02	1494	42	73	T-58	343	281
P-59-02	1519	42	74	T-59	347	285
P-60-02	1545	42	75	T-60	351	288
P-61-02	1571	42	76	T-61	355	292
P-62-02	1597	42	78	T-62	358	295
P-63-02	1622	42	79	T-63	362	299
P-64-02	1648	42	80	T-64	366	302
P-65-02	1674	42	81	T-65	370	306
P-66-02	1700	42	82	T-66	374	309
P-67-02	1725	42	83	T-67	378	312
P-68-02	1751	42	84	T-68	382	316
P-69-02	1777	42	85	T-69	386	319
P-70-02	1803	42	86	T-70	390	323
P-71-02	1828	42	88	T-71	393	326
P-72-02	1854	42	89	T-72	397	330

nazwa	S[mm]	L[mm]	U [V]	kod innej	cn	cr
P-73-02	1880	42	90	T-73	401	333
P-74-02	1906	42	91	T-74	405	337
P-75-02	1931	42	92	T-75	409	340
P-76-02	1957	42	93	T-76	413	344
P-77-02	1983	42	94	T-77	417	347
P-78-02	2009	42	95	T-78	421	351
P-79-02	2034	42	96	T-79	424	354
P-80-02	2060	42	98	T-80	428	358
P-81-02	2086	42	99	T-81	432	361
P-82-02	2112	42	100	T-82	436	365
P-83-02	2137	42	101	T-83	440	368
P-84-02	2163	42	102	T-84	444	371
P-85-02	2189	42	103	T-85	448	375
P-86-02	2215	42	104	T-86	452	378
P-87-02	2240	42	105	T-87	456	382
P-88-02	2266	42	107	T-88	459	385
P-89-02	2292	42	108	T-89	463	389
P-90-02	2318	42	109	T-90	467	392
P-91-02	2343	42	110	T-91	471	396

KABLE GRZEJNE POJEDYŃCZE

nazwa	S[mm]	D[mm]	U [V]		cn	cr
K1-100	800	11	19		194	101
K1-105	840	11	19		198	102
K1-110	880	11	20		202	103
K1-115	920	11	20		206	105
K1-120	960	11	21		210	106
K1-125	1000	11	21		214	107
K1-130	1040	11	22		218	108
K1-135	1080	11	22		222	110
K1-140	1120	11	23		227	111
K1-145	1160	11	23		231	112
K1-150	1200	11	24		235	113
K1-155	1240	11	24		239	115
K1-160	1280	11	25		243	116
K1-165	1320	11	25		247	117
K1-170	1360	11	26		251	118
K1-175	1400	11	26		255	120
K1-180	1440	11	27		260	121
K1-185	1480	11	27		264	122
K1-190	1520	11	28		268	124
K1-195	1560	11	29		272	125
K1-200	1600	11	29		276	126
K1-205	1640	11	30		280	127
K1-210	1680	11	30		284	129
K1-215	1720	11	31		289	130
K1-220	1760	11	31		293	131
K1-225	1800	11	32		297	132
K1-230	1840	11	32		301	134
K1-235	1880	11	33		305	135
K1-240	1920	11	33		309	136
K1-245	1960	11	34		313	137
K1-250	2000	11	34		317	139
K1-255	2040	11	35		322	140
K1-260	2080	11	35		326	141
K1-265	2120	11	36		330	143
K1-270	2160	11	36		334	144
K1-275	2200	11	37		338	145
K1-280	2240	11	37		342	146

nazwa	S[mm]	L[mm]	U [V]	kod innej	cn	cr
K1-285	2280	11	38		346	148
K1-290	2320	11	38		350	149
K1-295	2360	11	39		355	150
K1-300	2400	11	39		359	151
K1-305	2440	11	40		363	153
K1-310	2480	11	40		367	154
K1-315	2520	11	41		371	155
K1-320	2560	11	41		375	157
K1-325	2600	11	42		379	158
K1-330	2640	11	42		384	159
K1-335	2680	11	43		388	160
K1-340	2720	11	43		392	162
K1-345	2760	11	44		396	163
K1-350	2800	11	44		400	164
K1-355	2840	11	45		404	165
K1-360	2880	11	46		408	167
K1-365	2920	11	46		412	168
K1-370	2960	11	47		417	169
K1-375	3000	11	47		421	170
K1-380	3040	11	48		425	172
K1-385	3080	11	48		429	173
K1-390	3120	11	49		433	174
K1-395	3160	11	49		437	176
K1-400	3200	11	50		441	177
K1-405	3240	11	50		446	178
K1-410	3280	11	51		450	179
K1-415	3320	11	51		454	181
K1-420	3360	11	52		458	182
K1-425	3400	11	52		462	183
K1-430	3440	11	53		466	184
K1-435	3480	11	53		470	186
K1-440	3520	11	54		474	187
K1-445	3560	11	54		479	188
K1-450	3600	11	55		483	189
K1-455	3640	11	55		487	191
K1-460	3680	11	56		491	192
K1-465	3720	11	56		495	193
K1-470	3760	11	57		499	195
K1-475	3800	11	57		503	196
K1-480	3840	11	58		507	197
K1-485	3880	11	58		512	198
K1-490	3920	11	59		516	200
K1-495	3960	11	59		520	201
K1-500	4000	11	60		524	202
K1-505	4040	11	60		528	203
K1-510	4080	11	61		532	205
K1-515	4120	11	61		536	206
K1-520	4160	11	62		541	207
K1-525	4200	11	63		545	208
K1-530	4240	11	63		549	210
K1-535	4280	11	64		553	211
K1-540	4320	11	64		557	212
K1-545	4360	11	65		561	214
K1-550	4400	11	65		565	215
K1-555	4440	11	66		569	216
K1-560	4480	11	66		574	217
K1-565	4520	11	67		578	219
K1-570	4560	11	67		582	220
K1-575	4600	11	68		586	221
K1-580	4640	11	68		590	222
K1-585	4680	11	69		594	224

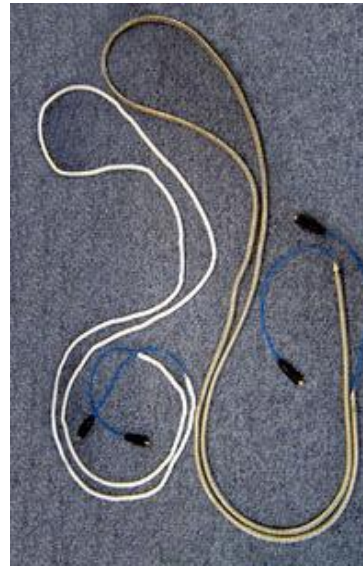

nazwa	S[mm]	L[mm]	U [V]	kod innej	cn	cr
K1-590	4720	11	69		598	225
K1-595	4760	11	70		603	226
K1-600	4800	11	70		607	228
K1-605	4840	11	71		611	229
K1-610	4880	11	71		615	230
K1-615	4920	11	72		619	231
K1-620	4960	11	72		623	233
K1-625	5000	11	73		627	234
K1-630	5040	11	73		631	235
K1-635	5080	11	74		636	236
K1-640	5120	11	74		640	238
K1-645	5160	11	75		644	239
K1-650	5200	11	75		648	240
K1-655	5240	11	76		652	241
K1-660	5280	11	76		656	243
K1-665	5320	11	77		660	244
K1-670	5360	11	77		664	245
K1-675	5400	11	78		669	247
K1-680	5440	11	78		673	248
K1-685	5480	11	79		677	249
K1-690	5520	11	79		681	250
K1-695	5560	11	80		685	252
K1-700	5600	11	81		689	253
K1-705	5640	11	81		693	254
K1-710	5680	11	82		698	255
K1-715	5720	11	82		702	257
K1-720	5760	11	83		706	258
K1-725	5800	11	83		710	259
K1-730	5840	11	84		714	260
K1-735	5880	11	84		718	262
K1-740	5920	11	85		722	263
K1-745	5960	11	85		726	264
K1-750	6000	11	86		731	266
K1-755	6040	11	86		735	267
K1-760	6080	11	87		739	268
K1-765	6120	11	87		743	269
K1-770	6160	11	88		747	271
K1-775	6200	11	88		751	272
K1-780	6240	11	89		755	273
K1-785	6280	11	89		759	274
K1-790	6320	11	90		764	276
K1-795	6360	11	90		768	277
K1-800	6400	11	91		772	278
K1-805	6440	11	91		776	280
K1-810	6480	11	92		780	281
K1-815	6520	11	92		784	282
K1-820	6560	11	93		788	283
K1-825	6600	11	93		793	285
K1-830	6640	11	94		797	286
K1-835	6680	11	94		801	287
K1-840	6720	11	95		805	288
K1-845	6760	11	95		809	290
K1-850	6800	11	96		813	291
K1-855	6840	11	96		817	292
K1-860	6880	11	97		821	293
K1-865	6920	11	98		826	295
K1-870	6960	11	98		830	296
K1-875	7000	11	99		834	297
K1-880	7040	11	99		838	299
K1-885	7080	11	100		842	300
K1-890	7120	11	100		907	333

nazwa	S[mm]	L[mm]	U [V]	kod innej	cn	cr
K1-895	7160	11	101		911	334
K1-900	7200	11	101		915	335
K1-905	7240	11	102		920	336
K1-910	7280	11	102		924	338
K1-915	7320	11	103		928	339
K1-920	7360	11	103		932	340
K1-925	7400	11	104		936	341
K1-930	7440	11	104		940	343
K1-935	7480	11	105		944	344
K1-940	7520	11	105		949	345
K1-945	7560	11	106		953	346
K1-950	7600	11	106		957	348
K1-955	7640	11	107		961	349
K1-960	7680	11	107		965	350
K1-965	7720	11	108		969	352
K1-970	7760	11	108		973	353
K1-975	7800	11	109		977	354
K1-980	7840	11	109		982	355
K1-985	7880	11	110		986	357
K1-990	7920	11	110		990	358

Wymiary traktować orientacyjnie. Rzeczywisty rozmiar może się różnić do 3% ze względu na wydłużenie drutu oporowego po nagraniu oraz różnice w zachodzeniu na siebie wypustów ceramicznych

Ceny traktować poglądowo. Są to ceny jednostkowe netto PLN z dnia

2004-02-27

System kodowania:

-pierwsza litera : P-prostokątna, R-rozstawna, T-taśma, K1-kabel pojedynczy, K2-kabel podwójny

Cyfry w oznaczeniach mat prostokątnych i rozstawnych:

-pierwsze 2 lub 3 cyfry- ilość elementów ceramicznych na szerokość

-ostatnie 2 cyfry- ilość elementów ceramicznych na długość

Raster ceramiki: szerokość 26mm, długość 21mm

Cyfry w oznaczeniach taśm grzejnych: ilość elementów grzejnych na szerokość

uwagi:

Różnica konstrukcyjna pomiędzy matą prostokątną np.: P-47-02 , a taśmą T-47 polega na rozmieszczeniu doprowadzeń

Różnic konstrukcyjnych pomiędzy dwurzędową matą prostokątną np.: P-47-02 , a rozstawną R-47-02 nie ma żadnych

Dla kabli grzejnych podwójnych oba oznaczenia są prawidłowe

Cena regeneracji może być inna przy innym zakresie naprawy

Przy doborze pamiętać, że grzejniki dobrze zginają się jedynie na szerokości [wymiar S.]

Są także wykonywane grzałki na prąd 74A (grubszy drut oporowy)



"LMS" s.c.

Tadeusz Macioła , Krzysztof Scheithauer

ul. Hermisza 9 , 41-800 ZABRZE

tel. (032) 2787050 , fax (032) 2787051, tel .kom.0502 035580; 0601 456491